

ARD1
Arduino Mega 2560

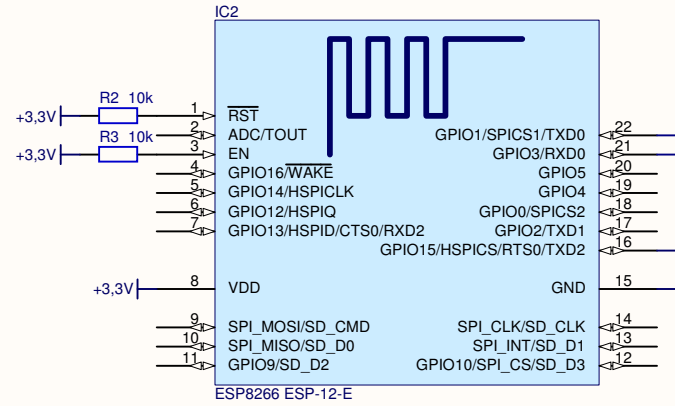

Projekt:
Gartensteuerung Vo.1a Arduino Mega2560 Board

Tomtom
DL1MFK
Datum : 15.09.2017
Uhrzeit : 21:09:33
Rev..*

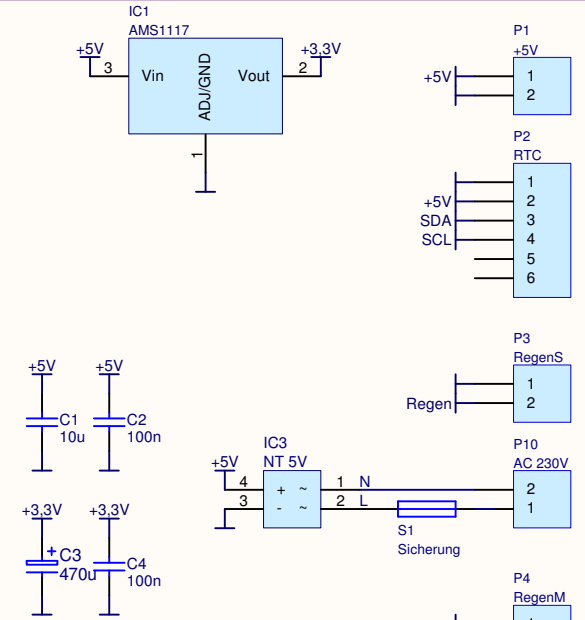
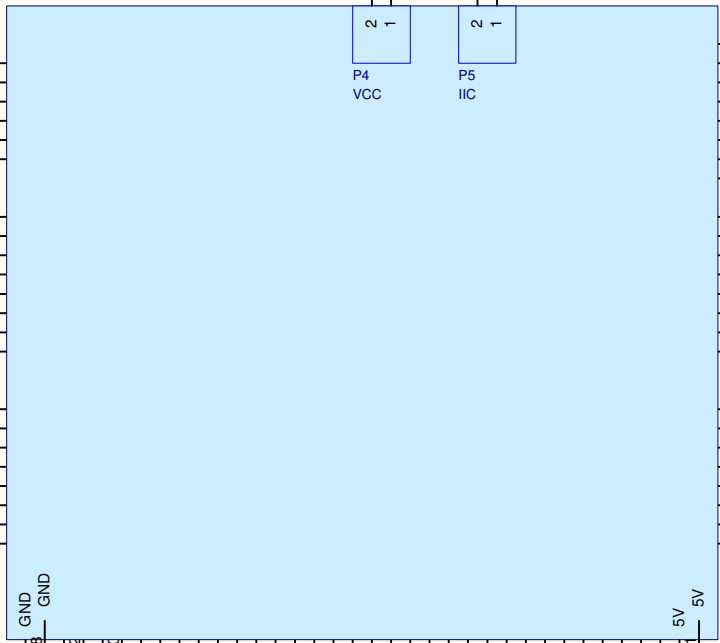
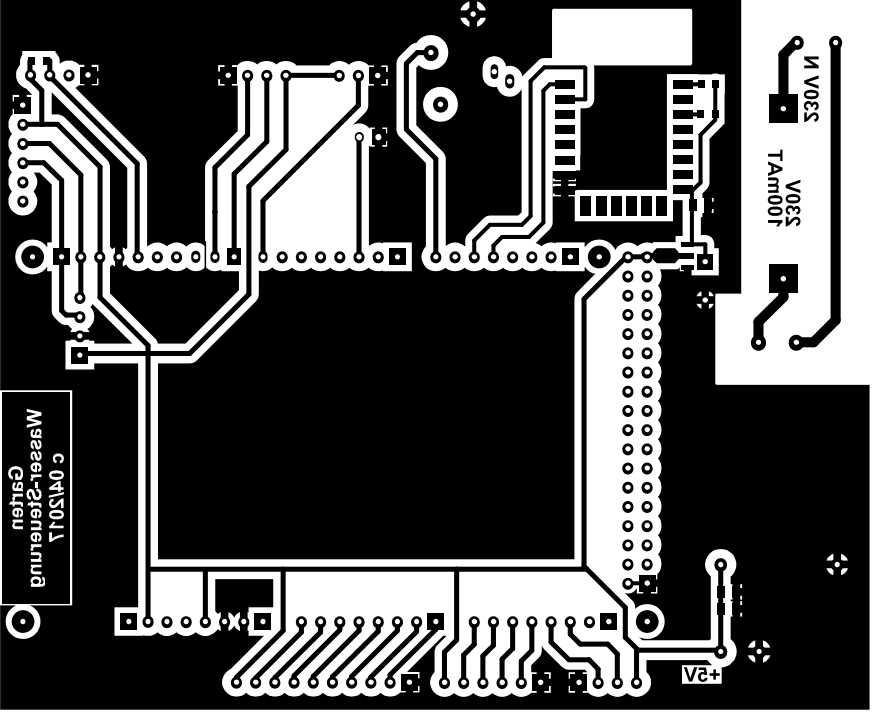

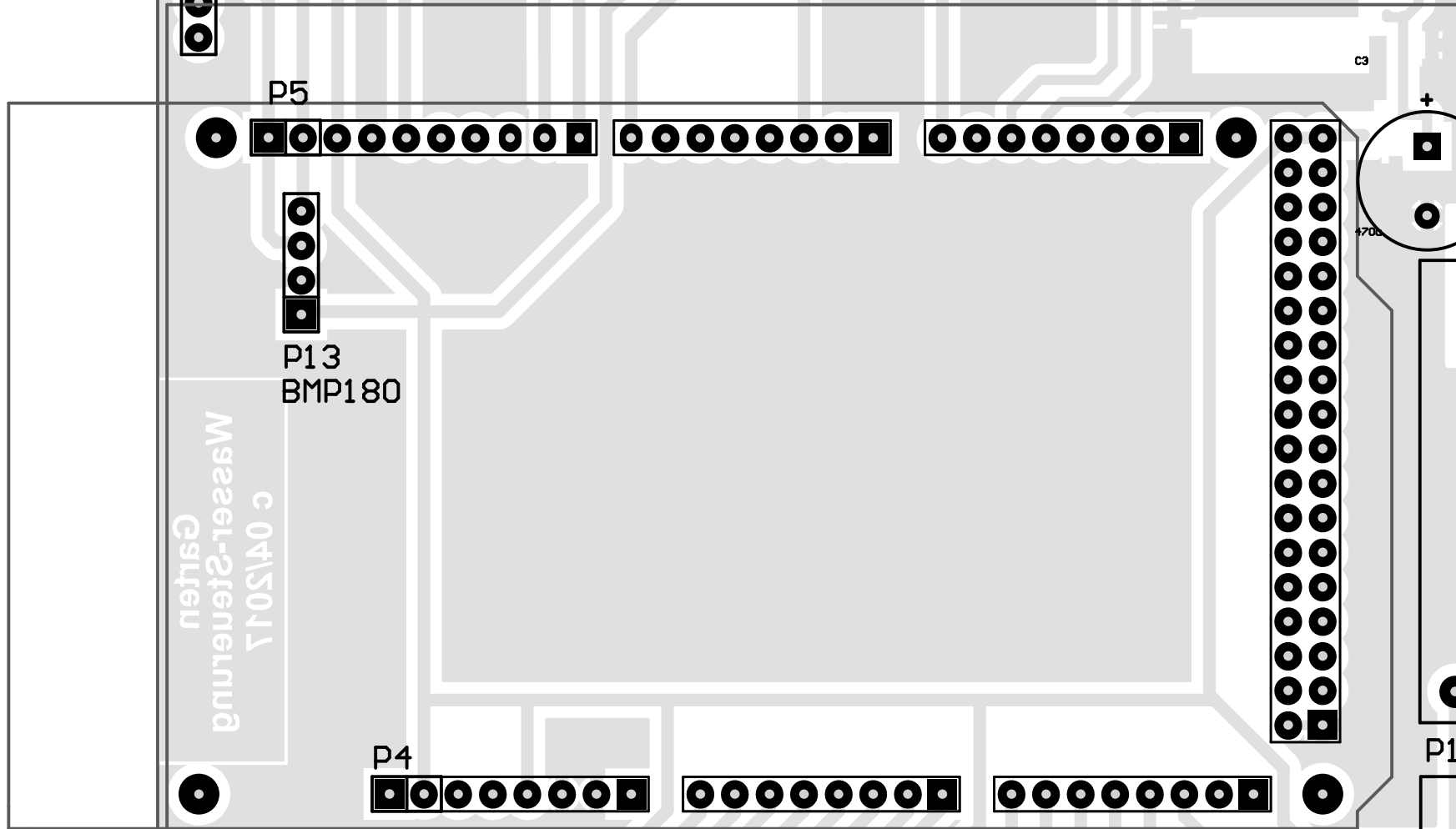

P11
DHT22

P12
USchall

P6
DFMMesser

P2
RTC

P4
RegenM

P3
RegenS

P5

P13
BMP180

ARD15015
Wasser-Garten

P4

ARD1

P9 Re_1-8

P7 Rel_1-4

P8 Rel_5-6

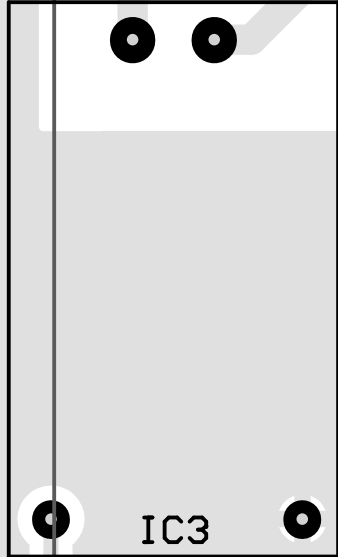
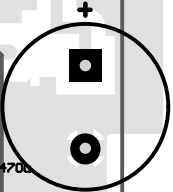
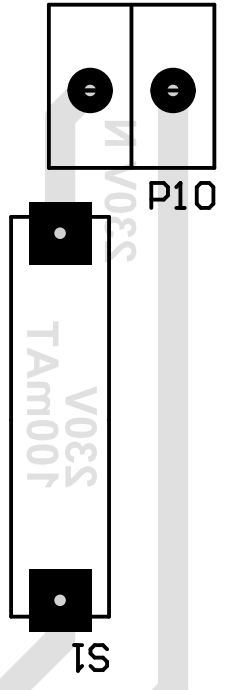
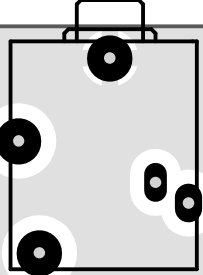

P1 +5U

