

SuperProbe Mr Carlsons Lab
V01a DL1MFK 06/21

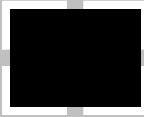

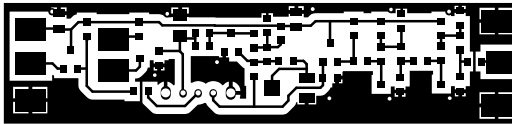

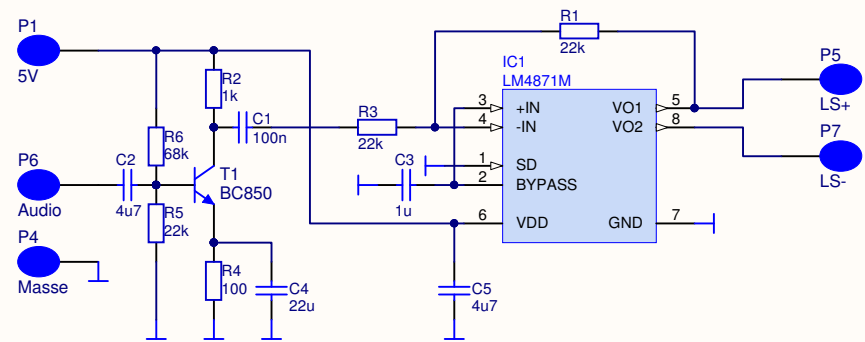



P6 Audio

P4 Masse

P1 6V

P7 LS-

C2
4u7

R5
22k

LM4871M
IC1

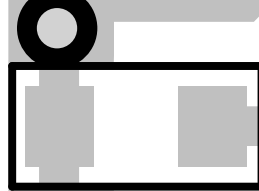
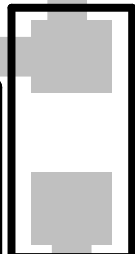
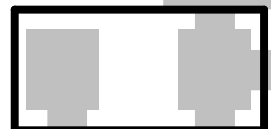

C3
1u

R4
100

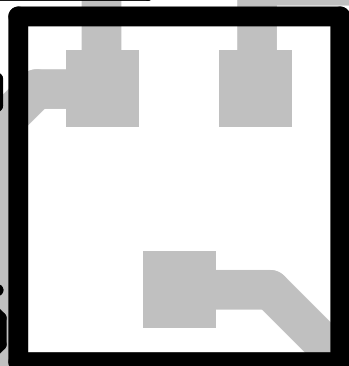

R6
68k



C5
4u7



+



T1
BC850

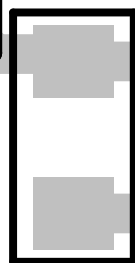

R2
1k



C1
100n



R3
22k



R1
22k

+



C4
22u



P5 LS+

DL1MFK V01a 06/21
SuperProbeAmp Mr Carlsons Lab

DL1MFK V01a 06/21
SuperProbeAmp Mr Carlsons Lab



